

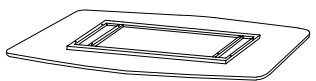





ASSEMBLY INSTRUCTION

| | | |
|---|---|-----|
| A |  | x1 |
| B |  | x1 |
| C |  | x2 |
| D |  | x14 |
| E |  | x14 |
| F |  | x6 |
| G |  | x1 |

step1

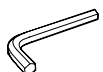
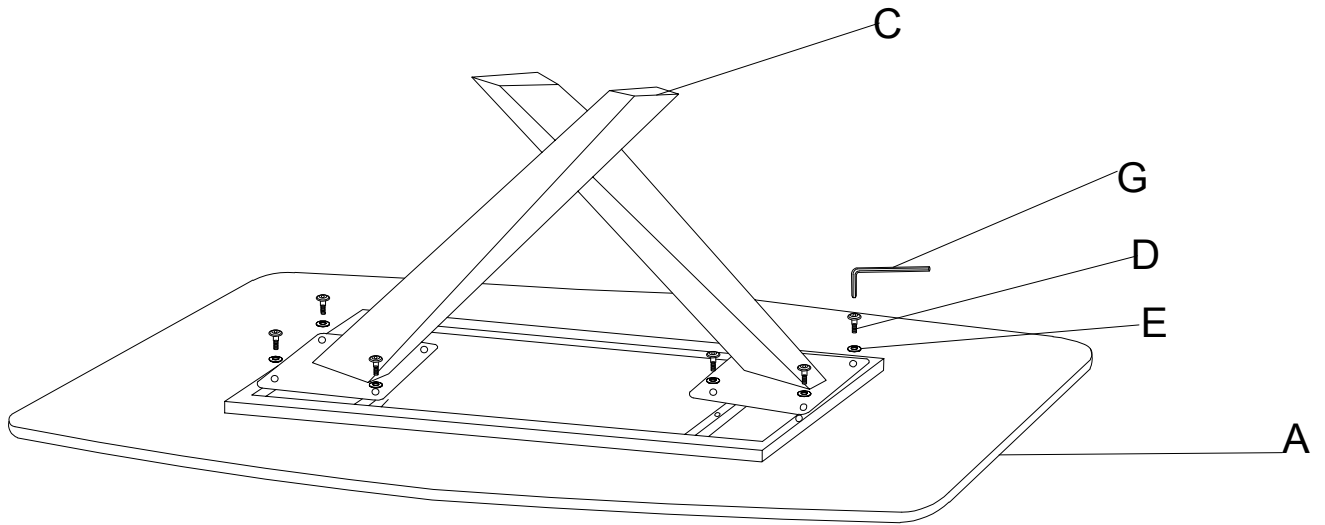

step2

